

High-Performance Eddy Current Flaw Detector

NEW



- EN-15548 compliant
- Rugged and field-ready
- Vibrant color display
- Intuitive interface with application presets
- Complete archiving and reporting solution

NORTEC 600 Eddy Current Flaw Detector

Performance and Innovation in Eddy Current

Olympus combines its latest advancements in high-performance digital circuitry and eddy current flaw detection into one compact and durable portable unit—the new NORTEC® 600 eddy current flaw detector. With its crisp and vivid 5.7-inch VGA display and true full-screen mode, the NORTEC 600 eddy current flaw detector is capable of producing highly visible and contrasting eddy current signals in any lighting condition.

The redesigned interface of the NORTEC 600 eddy current flaw detector borrows the intuitive, knob-operated navigation of its NORTEC predecessors and combines it with the simple menu structure and highly efficient direct-access keys of other popular Olympus instruments. Available in four versatile models, the NORTEC 600 eddy current flaw detector offers a wide range of innovative functionalities, including an Application Selection menu, an all-in-one display, real-time readings, and signal calibration in Freeze mode, helping ensure that inspections are quick and easy for any level of operator.



Reliable and Robust

Based on an already field-proven instrument case, the NORTEC 600 eddy current flaw detector is built for endurance in harsh field conditions. Its casing's durability and resistance to extreme weather makes the NORTEC 600 flaw detector an instrument you can trust for any eddy current inspection job.

Portable and Lightweight

The NORTEC 600 eddy current flaw detector weighs only 1.6 kg (3.7 lb) and is delivered with a factory-installed hand strap that provides direct thumb access to the key controls, offering genuine handheld versatility to operators.



Key Features

- Designed to meet the requirements of IP66.
- EN-15548 compliant.
- Long battery life (up to 10 hours).
- Bright, 5.7-inch VGA display.
- Full-screen option in any display mode.
- Improved filters for rotary scanner mode.
- Intuitive interface with Application Selection presets.
- All-settings configuration page.
- 10 Hz to 12 MHz frequency capacity.
- Automatic internal balancing (BNC connector).
- Up to two real-time readings.
- True automatic mixing.
- Storage capacity of up to 500 files (program and data).
- Onboard file preview.

Versatility and Compatibility

Four Models for All Your Needs

The NORTEC® 600 eddy current flaw detector is available in four versatile instrument models to meet the widest range of inspection needs. From the basic model upward, each unit unlocks more features. For maximum convenience, additional features can also be unlocked remotely.

Supported feature or mode	N600 (basic)	N600C (conductivity)	N600S (scanner)	N600D (dual freq.)
Signal calibration in Freeze mode	✓	✓	✓	✓
Real-time readings	✓	✓	✓	✓
Application Selection	✓	✓	✓	✓
All-in-one display	✓	✓	✓	✓
POWERLINK probe support	✓	✓	✓	✓
Conductivity and coating thickness measurement		✓*	✓	✓
Rotary scanner			✓	✓
Dual frequency and mixing				✓

*One conductivity probe 9222340 [U8690027], standard 9522103 [U8880111], and calibration shims 0320806 [U8840160] included.



Two Probe Connectors

All models of the NORTEC 600 eddy current flaw detector come with the standard LEMO 16-way universal connector, as well as a BNC connector for absolute probes. Simply select the connector in the instrument interface. When reading from the BNC connector, the instrument features automatic internal balancing for hassle-free operation.



The 16-way LEMO connector also supports the POWERLINK® NORTEC probe technology, which features automatic probe recognition and instrument presets for quicker setups.

Compatible with Current Procedures and Other Manufacturers

To simplify inspection, the NORTEC 600 eddy current flaw detector includes all the legacy modes and layouts used in existing NORTEC-specified procedures, as well as those used by many other equipment manufacturers. Standard impedance plane view, sweep mode (strip chart), split screens, adjustable null point, crosshairs, improved filter response, reference signal display, and several other useful features are all part of the NORTEC 600 flaw detector package.

Compatible with many other probe and rotary scanner manufacturers' products, the NORTEC 600 eddy current flaw detector's accessories include cables and adaptors such as a 12-way LEMO, an 11-way Fischer, and more. The proper adaptor or scanner cable make it possible to benefit from all the outstanding capabilities of the NORTEC 600 flaw detector, without investing heavily in probes and accessories.

One of the Most Brilliant Displays in the Industry

Vibrant VGA Display

The NORTEC® 600 eddy current flaw detector has one of the most brilliant displays available on the portable eddy current flaw detector market. The unique brightness, resolution, and definition of its 5.7-inch VGA display make it possible to interpret eddy current signals at a distance. The user-selectable color schemes help ensure that the display is both clear and easy-to-read whether you are using the NORTEC 600 flaw detector indoors or outside.



True Full-Screen Display

In addition to impressive size and brightness, the NORTEC 600 eddy current flaw detector's VGA display also features a new full-screen mode that can be activated simply by touching a key.

Available for all applications and in all display modes, the full-screen mode really comes in handy when reading signals over an extended period of time.

Depending on your NORTEC 600 flaw detector model, you can choose between the following displays:

- Single impedance plane.
- Dual impedance plane.
- Sweep (strip chart).
- Split screen (sweep + impedance).
- Waterfall.
- All-in-one display featuring up to 3 configurable traces.

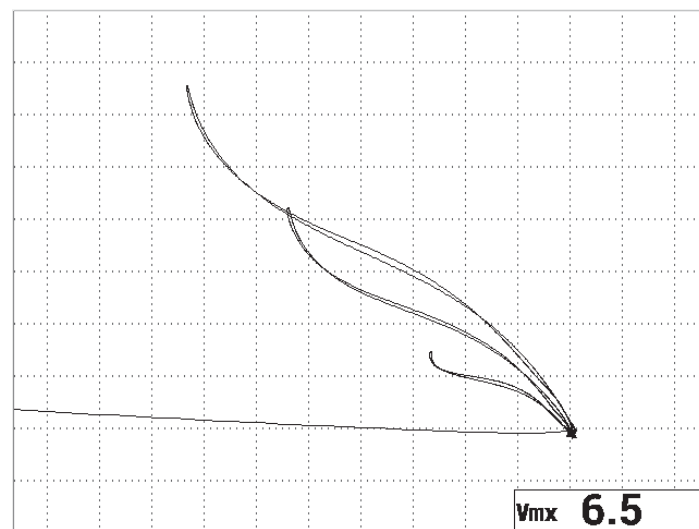

Intuitive, Easy-to-Use Interface

Productivity and Simplicity Combined

When developing the NORTEC® 600 eddy current flaw detector's user interface, Olympus wanted to create the best possible combination of simplicity, efficiency, and intuitiveness. The result is a totally redesigned navigation system that significantly reduces the learning curve, all while maintaining a high level of productivity during inspection, even for novice operators.

All the benefits of this newly redesigned user interface are available in more than 15 languages.



Application Selection and All-Settings

To meet customers' needs, the NORTEC 600 eddy current flaw detector's new carefully designed Application Selection menu contains predefined factory settings that save time during signal calibration. The instrument also features a new All-Settings page that displays all of the parameters on the screen at once, so that you can quickly configure the instrument to conform to a particular procedure.

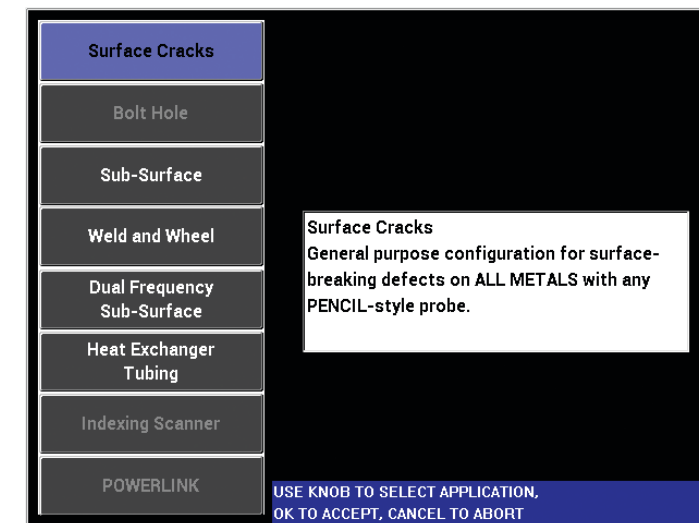

Signal Calibration in Freeze Mode

This new and innovative feature of the NORTEC 600 flaw detector enables operators to focus their attention on the movement of the probe to help ensure that they achieve a satisfactory scan. Afterward, the gain and angle can be adjusted while the signal is in Freeze mode.

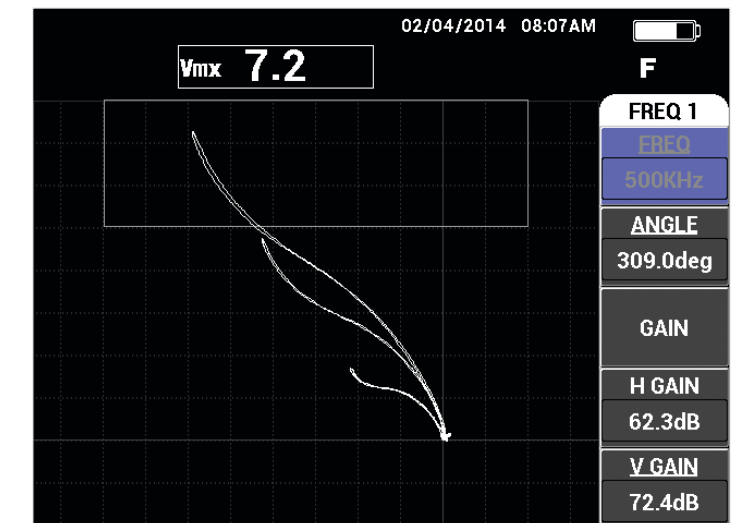

Outstanding Signal Performance for Real-World Applications

Surface Inspection

The high-performance, state-of-the-art electronics and unique vibrant display of the NORTEC® 600 eddy current flaw detector provide an unprecedented signal quality for surface inspection.

The NORTEC 600 flaw detector also comprises all the standard features for medium-high frequency surface inspection, including impedance plane views, 10 × 10 grid, sweep (strip chart), multiple alarm configurations, automatic lift-off, etc. Newly added features such as null point crosshairs, fine (expanded) and web grids, and the automatic internal balance circuit (for BNC connector) make the NORTEC 600 eddy current flaw detector an extremely proficient surface inspection tool.

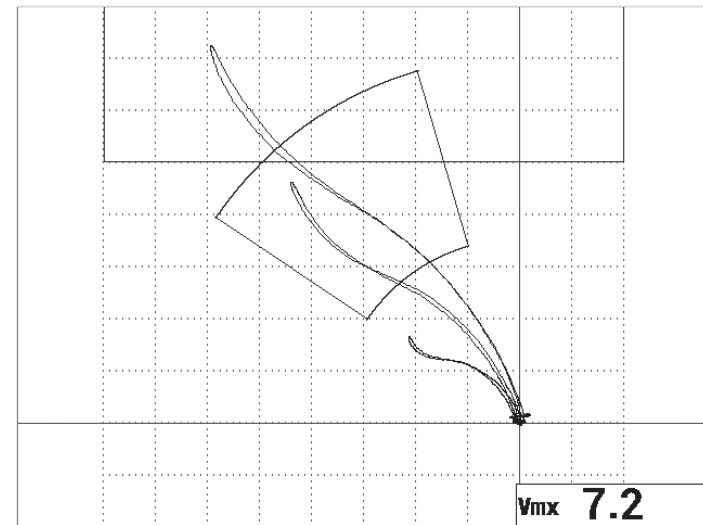

Wheel Inspection

The efficiency of the NORTEC 600 eddy current flaw detector's advanced circuitry is best demonstrated when performing wheel inspections. The probes that are used for this application usually present lower-amplitude signals, often requiring a pre-amplifier. However, the wide gain range (0–100 dB) and state-of-the-art electronics of the NORTEC 600 flaw detector deliver excellent quality signals during wheel inspection, without requiring a preamplifier.

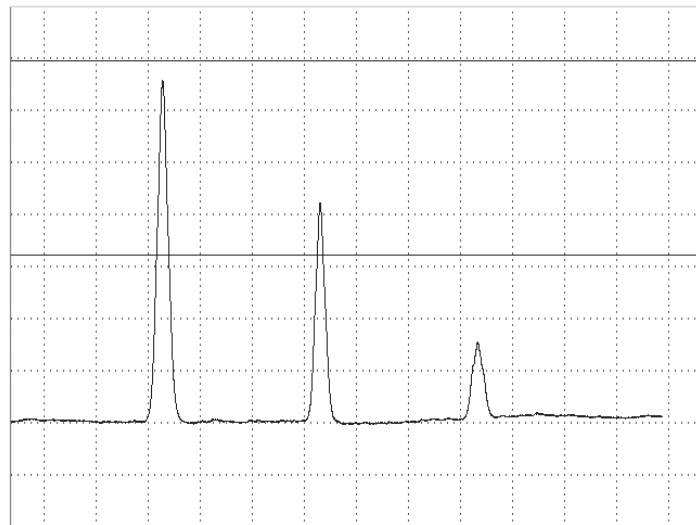
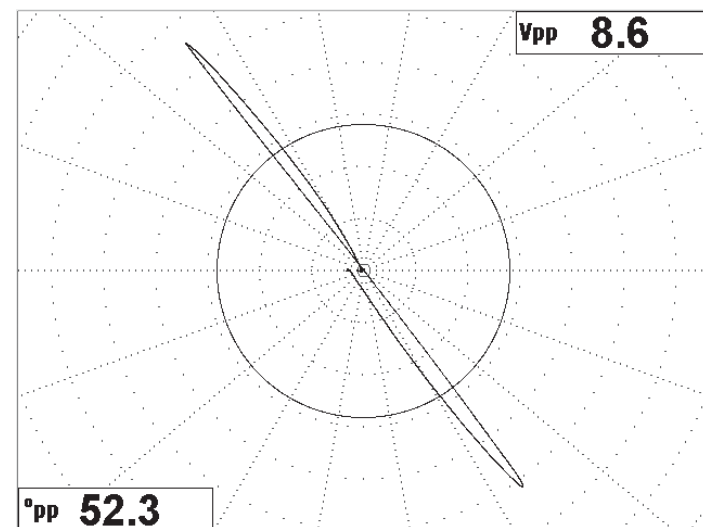

Improved Filters for Bolt Hole Inspection (600S and 600D)

The simplified configuration and improved filter system of the NORTEC 600® eddy current flaw detector make it an ideal instrument for bolt hole (rotary scanner) inspection. The new NORTEC 600 flaw detector filters are set by default to a “figure 6” response, the typical shape of the rotary bolt hole application. The filters can also be set to the “figure 8” response, as desired. For an even easier configuration, operators can activate the new Link option, which automatically adjusts the filter settings according to the scanner's speed settings.

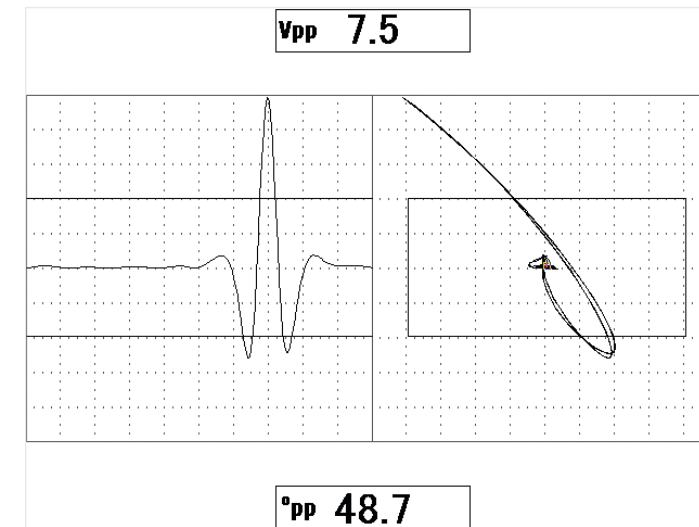

Conductivity and Coating Thickness Measurement (600C, 600S, and 600D)

The improved conductivity mode of the NORTEC 600 eddy current flaw detector features a new, straightforward calibration Wizard featuring user-defined conductivity and coating thickness references. The NORTEC 600 flaw detector is capable of measuring conductivity and non-conductive coating thicknesses of up to 0.64 mm (0.025 in.) on non-ferromagnetic materials.

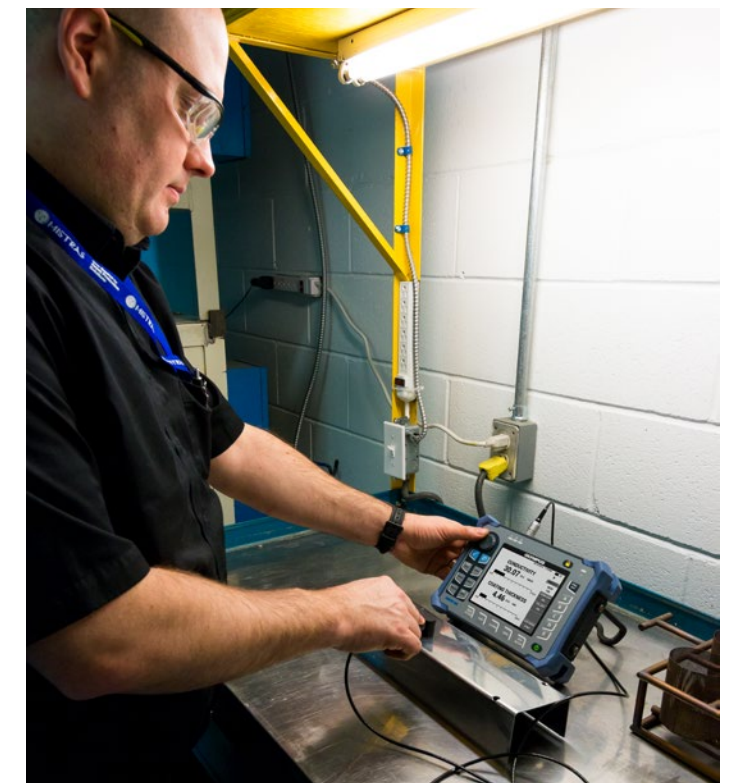
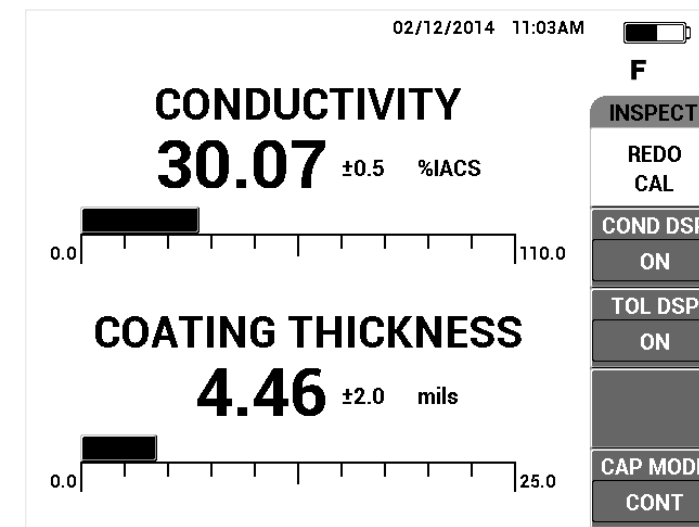

Optimized for Weld Inspection

Thanks to its portable, rugged, and durable format, the NORTEC® 600 eddy current flaw detector is ideally suited for performing weld inspection in extreme environments. When inspecting a weld while using rope access, the chest harness can be attached to its four-point anchors.

The NORTEC 600 flaw detector features an inspection-ready weld setup that helps simplify instrument preparation and calibration. Paint thickness can also be evaluated in both single or dual frequency mode (the NORTEC 600D model only).

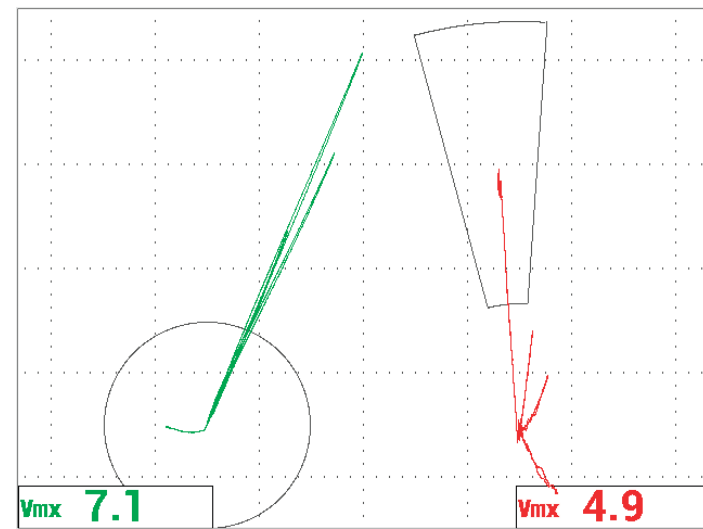

Legacy Indexing Scanner Support in Critical Hole Inspection (600s and 600D)

With the NORTEC 600 eddy current flaw detector, inspecting critical holes is simple and reliable. Thanks to its legacy PS5 indexing rotary scanner support, improved waterfall display, and new layer cursor, the NORTEC 600 flaw detector pinpoints the location of flaws in layered structures with ease.



PS5-AL legacy indexing scanner

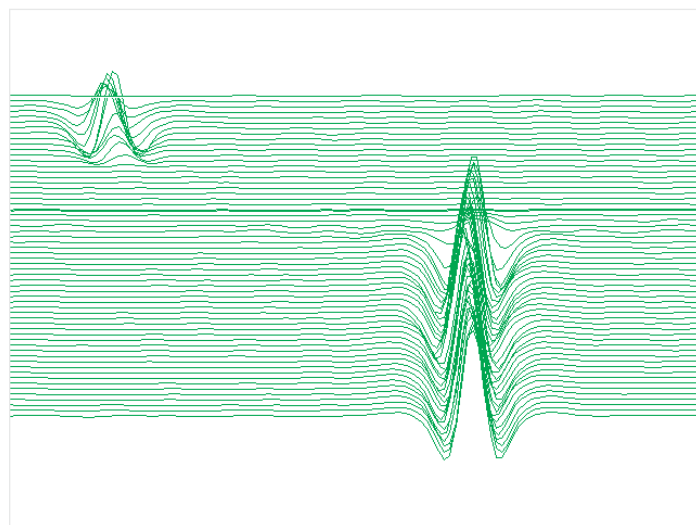

Waterfall display with new layer identification cursor.

Innovation in Dual Frequency Inspection

All-in-One Display (600D)



The new All-in-One display features up to 3 configurable traces for frequency 1, frequency 2, and mixed channels. Each channel can be displayed as impedance or strip chart, with independent display position controls.



Automatic Mixing (600D)

The new Auto-Mix feature of the NORTEC® 600 eddy current flaw detector instantly mixes signals so that the residual (subtracted) signal is reduced to a minimum. This is particularly useful for heat exchanger tubing inspection.

Real-Time Readings

With the Real-Time Readings parameter, you can choose to display up to two real-time signal measurements in standard or full-screen modes. Displaying a variety of measurements reveals the various amplitude of angle (phase) characteristics of the signal.

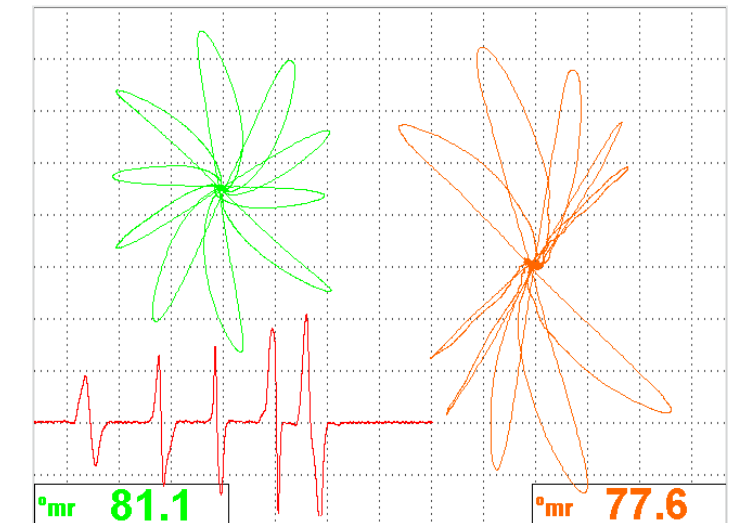

- Choice of 3 peak-to-peak amplitude measurements (horizontal, vertical, or magnitude).
- Horizontal or vertical maximum distance from null point.
- Angle (phase) measurement of signal as peak-to-peak.

Easy Archiving and Reporting

One-Touch, Instant File Saving or Reference Signal Display

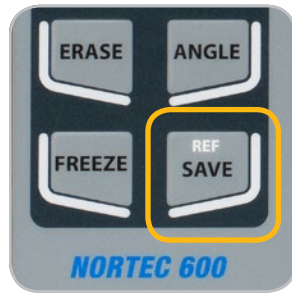

Pressing the new SAVE key instantly stores the current settings (program) and signals (data) in the instrument's memory, together in a single file for maximum convenience and user-friendliness.

The capture function can also be delayed to facilitate correct hand positioning and a proper scanning motion before the unit actually begins recording. The onboard memory features room for 500 files, which can be transferred to another unit or a computer as needed.

Background reference signals can also be recalled from the memory in a new, faster way: simply press and hold the SAVE key while live signals are displayed on the screen to send those same signals to the background.

Intuitive File Management

The new File Manager menu of the NORTEC® 600 eddy current flaw detector has been completely streamlined without sacrificing convenience or productivity. It features a new file preview function makes it simple to visually browse through different files. Once the proper file is found, it can be recalled at the user's convenience.

The File Manager menu also permits editing, overwriting, and deleting any file with a minimum number of operations. The onboard Text Editor comes in handy for editing file names, user and instrument information, or simply adding notes while still on site.

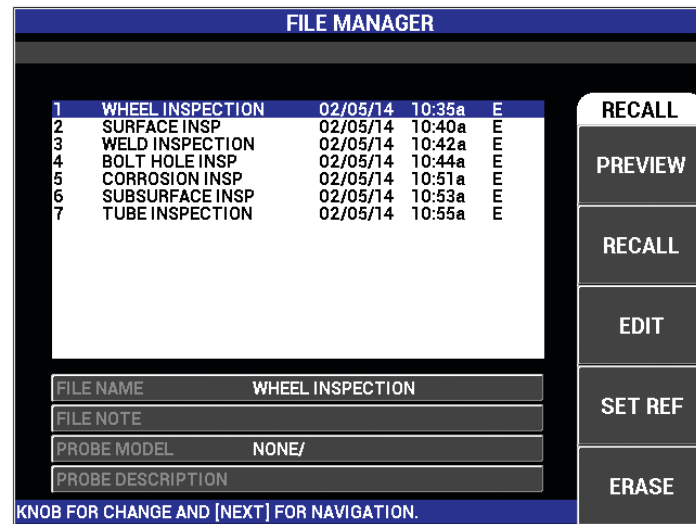

Easy Archiving with NORTEC PC Software

Anytime during inspection, recorded indications can be viewed with the new NORTEC® PC software. The NORTEC PC software enables the easy exchange of files between the NORTEC 600 instrument and your computer. Communication is established via a USB cable, and all files can be quickly downloaded or uploaded. Once files are on the computer, they can be viewed, copied to the clipboard, or exported as a PDF report. NORTEC PC software also features a new, "PDF ALL" function that generates an entire inspection report with a single click, making archiving very easy.

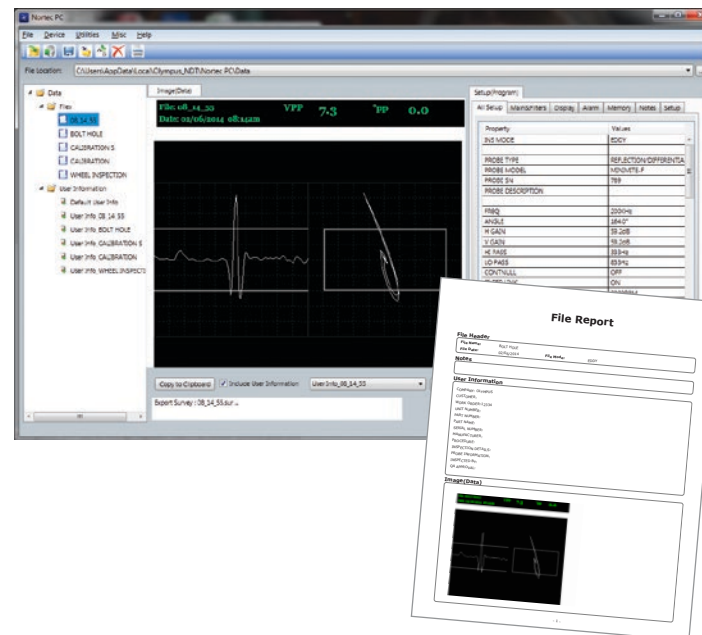

Easy Integration of NORTEC 600 Eddy Current Flaw Detector

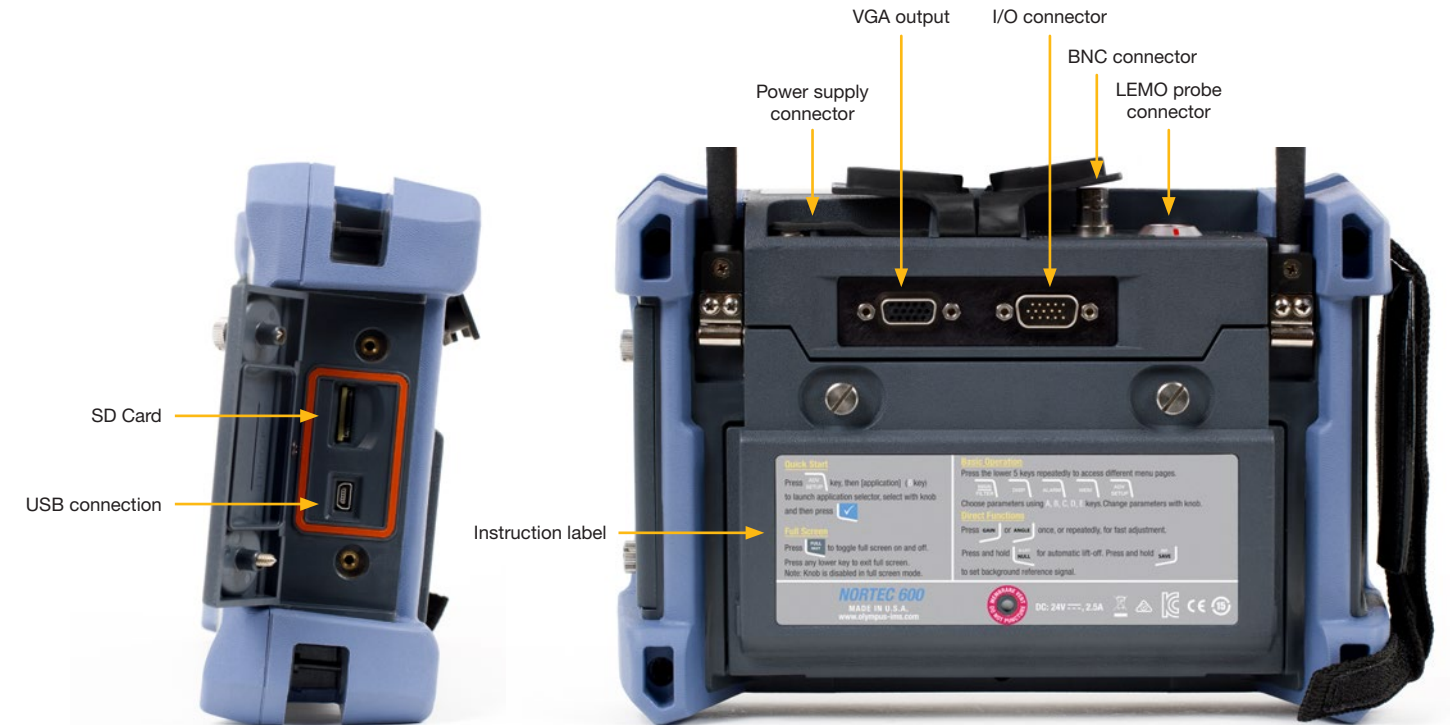

The NORTEC® 600 eddy current flaw detector merges seamlessly into any integrated eddy current detection system. Its numerous software and hardware features help ensure that the instrument is capable of performing consistent flaw detection in industrial environments. The NORTEC 600 flaw detector specifications and functions were designed with integration in mind.

- Designed to meet the requirements of IP66.
- 0 °C to 50 °C (32 °F to 122 °F) operating temperature range.
- Continuous null filter.
- Strip chart view with sweep alarm.
- 6 kHz measurement rate.
- Remote Control from NORTEC PC software.
- Alarm outputs.
- Analog outputs.
- Digital inputs.

Useful Optional Accessories

You can increase the performance and usability of your NORTEC 600 flaw detector with more than ten optional accessories.



NORTEC 600 Basic Specifications*

For complete specifications list, please download the full NORTEC® 600 Eddy Current Flaw Detector user's manual at www.olympus-ims.com.

Housing	
Overall dimensions (width x height x depth)	236 mm x 167 mm x 70 mm (9.3 in. x 6.57 in. x 2.76 in.)
Weight	1.7 kg (3.7 lb), including lithium-ion battery.
Standards or directives	EN-15548, CE, WEEE, FCC (USA), IC (Canada), RoHS (China), RCM (Australia and New Zealand).
Power requirements	AC Mains: 100 VAC to 120 VAC, 200 VAC to 240 VAC, 50 Hz to 60 Hz.
Input and Outputs	One USB 2.0 peripheral port, one standard VGA analog output port, one 15-pin I/O port (male) with 6 analog outputs, 3 alarm outputs.
Environmental conditions	
Operating temperature	-10°C to 50°C (14°F to 122°F)
Storage temperature	-20°C to 60°C (-4°F to 140°F) [with batteries] and -20°C to 70°C (-4°F to 158°F) [without batteries]
IP rating	Designed to meet the requirements of IP66.
Battery	
Battery type	Single lithium-ion rechargeable battery or optional AA-size alkaline batteries (in 8-cell holder).
Battery life	Up to 10 hours of standard operation; 6 hours to 8 hours when operating rotary scanners.
Display	
Display size (W x H, diagonal)	117.4 mm x 88.7 mm, 146.3 mm (4.62 in. x 3.49 in., 5.76 in.)
Display type	Full VGA (640 x 480 pixels) color, transfective LCD (liquid crystal display).
Screen modes	Normal or Full Screen, 8 color schemes.
Grids and display tools	Choice of 5 grids; crosshairs (single trace displays only).
Connectivity and memory	
PC software	NORTEC PC software, included in base NORTEC 600 kit. NORTEC PC enables viewing saved files and printing reports.
Data storage	500 files featuring user-selectable onboard preview.
Interface	
Languages	English, Spanish, French, German, Italian, Japanese, Chinese, Russian, Portuguese, Polish, Dutch, Czech, Hungarian, Swedish, and Norwegian.
Applications	Application Selection menu for easy and rapid configuration. Automatic lift-off key. Ambidextrous main controls.
Real-Time Readings	Choice of up to 2 real-time readings measuring signal characteristics (selection of 5 amplitude measurements and 1 angle measurement).

Standard Inclusions

The NORTEC® 600 eddy current flaw detector is available in any of the following configurations:

Model: Basic, Conductivity (C), Scanner (S), and Dual Frequency (D).

Power cord: Over 11 power cord models available (for the DC charger).

Keypad and instruction label: English, international (icons), Chinese, or Japanese.

“Getting Started” print manual: over 9 languages available.

Items included in all NORTEC 600 models*: NORTEC 600 instrument with factory-installed hand strap, getting started manual, calibration certificate, rigid transport case, DC charger with power cord, Li-ion battery, AA battery tray, USB communication cable, MicroSD memory card and adaptor, POWERLINK® probe cable, and NORTEC PC software and product manuals disc.

*Standard inclusions may vary depending on your location. Contact your local distributor.

Additional items included in NORTEC 600C model only: 19 mm, 60 kHz conductivity probe, conductivity calibration standard (set of 2: 29% and 59%), and calibration shims.

Online Videos

Watch the Nortec 600 product demonstration video and training videos at www.olympus-ims.com.

www.trisco.com.ph



DISTRIBUTED BY:
TRADERS INDUSTRIAL SUPPLY CO., INC.
 24th Floor Trident Tower, 312 Sen. Gil Puyat Ave., Makati City, Philippines
Contact: (+632) 8817-9004 / 8817-8914 / 8844-0749 @local LOCAL: 111, 121, 122, 124
Email: trisco@pltdsl.net / sales@trisco.com.ph

Eddy Current Specifications (all NORTEC models)	
Probe types	Absolute and differential in either bridge or reflection configuration. The instrument is fully compatible with NORTEC POWERLINK probes, as well as other main probe and accessory suppliers.
Probe connectors	16-pin LEMO and BNC featuring internal automatic balancing for BNC connector (absolute probes).
Frequency range	10 Hz to 12 MHz
Gain	0 dB to 100 dB in 0.1 or 1 dB increments.
Rotation	0° to 359.9° in 0.1° or 1° increments.
Sweep	Variable from 0.005 s to 10 s per division (total of 13.3 divisions with FINE grid).
Filters	Low-pass: 10 Hz to 2000 Hz and wide band. High-pass: off or 2 Hz to 1000 Hz, user-selectable in constant “figure 6” or “figure 8” filter type. Continuous null (low-frequency HP filter): 0.2 Hz, 0.5 Hz, 1.0 Hz.
Probe drive	LOW, MEDIUM, and HIGH (2 V, 5 V, 8 V).
Display erase, persistence	Display erase (0.1 s to 60 s), persistence (0.1 s to 10 s)
Available alarm types	3 simultaneous alarms. Choices include BOX (rectangle), POLAR (circle), SECTOR (pie), SWEEP (time-based), CONDUCTIVITY, and COATING THICKNESS.
Conductivity (NORTEC 600C, NORTEC 600S, and NORTEC 600D)	
Frequency	60 kHz or 480 kHz
Digital conductivity specification	Digital conductivity display from 0.9% to 110% IACS or 0.5 to 64 MS/m. Accuracy within ±0.5% IACS from 0.9% to 62% IACS and within ±1.0% of values over 62%. Meets or exceeds BAC 5651 specifications. Accuracies dependent on probe frequency, range of calibration, and coating thickness.
Non-conductive coating thickness	Nominal accuracy of non-conductive coating thickness of ±0.025 mm (±0.001 in.) from 0 mm to 0.254 mm (0.00 to 0.010 in.) range and ±0.50 mm over 10 mm to 0.5 mm (0.01 to 0.020 in.) range. Accuracy dependent on conductivity range, probe frequency, and range of calibration.
Scanners (NORTEC 600S and NORTEC 600D)	
Scanner compatibility	Operates Olympus scanners (MiniMite, Spitfire, RA-2000, and PS-5) and other major supplier scanners, from 120 RPM to 3,000 RPM.
Dual Frequency (NORTEC 600D)	
Frequency adjustment (dual frequency mode)	Two fully independent frequencies, operating in simultaneous injection.
MIX options	F1 - F2, F1 + F2, and automatic true mixing.

OLYMPUS SCIENTIFIC SOLUTIONS AMERICAS CORP. is certified to ISO 9001, ISO 14001, and OHSAS 18001.

*All specifications are subject to change without notice. All brands are trademarks or registered trademarks of their respective owners and third party entities. NORTEC and POWERLINK are registered trademarks of Olympus Corporation. Copyright © 2017 by Olympus.

